

# LEVOLOR®

## Sheer Shadings

### Persianas traslúcidas

### Stores diaphanes

INSTALLATION • OPERATION • CARE

INSTALACIÓN • FUNCIONAMIENTO • CUIDADO

INSTALLATION • FONCTIONNEMENT • ENTRETIEN

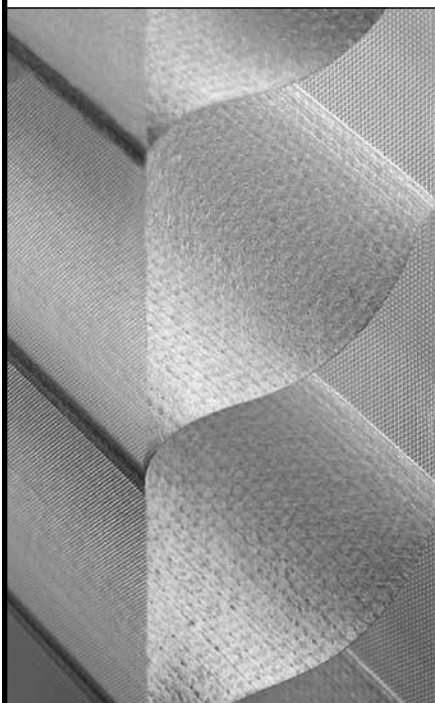

## Cordless Operating System

### Sistema operativo sin cordón

### Système sans cordon

# CONTENTS

---

## Getting Started

Product View .....	3
Tools and Fasteners Needed .....	4

## Installation

Installation Overview .....	5
Mount the Installation Brackets — Inside Mount .....	6 – 7
Mount the Installation Brackets — Outside Mount .....	7 – 9
Mount the Installation Brackets — Side Mount .....	9
Install the Shading .....	10
Attach the Magnetic Hold-Down Brackets (Optional) .....	10 – 11

## Operation

Operate the Shading .....	11
Troubleshooting .....	12 – 14

## Care

Removing the Shading .....	15
Cleaning Procedures .....	15 – 16

Warranty .....	16
----------------	----

---

Product View

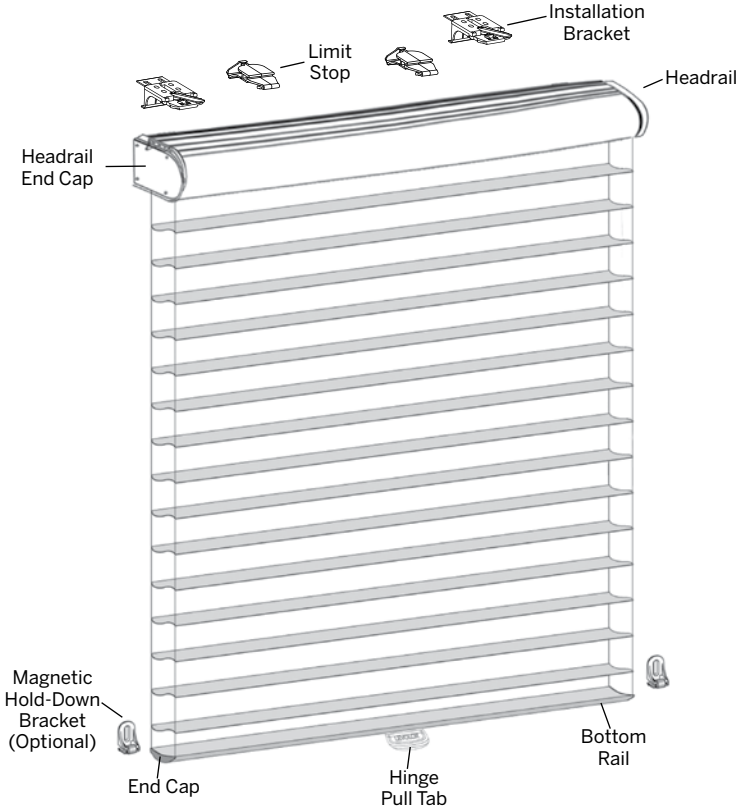

## GETTING STARTED

Thank you for purchasing LEVOLOR® Sheer Shadings. With proper installation, operation, and care, your new shadings will provide years of beauty and performance. Please thoroughly review this instruction booklet before beginning installation.

### Tools and Fasteners Needed

- Flat and Phillips head screwdrivers
- Level (laser level is recommended)
- Measuring tape and pencil
- Pliers and/or scissors (heavy-duty)
- Power drill,  $\frac{3}{32}$ " drill bit, and  $\frac{1}{4}$ " hex driver

In addition, you will need fasteners designed to work with your specific mounting surface(s).

- **#6 Hex Head Screws (Provided).** Two  $1\frac{1}{2}$ " screws are provided per installation bracket.
- **Longer #6 Hex Head Screws (Not Provided).** If using spacer blocks, use #6 screws long enough for a secure attachment.
- **Speed Nuts and Screws (Provided).** Extension brackets come with screws and speed nuts.
- **Drywall Anchors (Not Provided).** Use drywall anchors when mounting into drywall.



#6 x  $1\frac{1}{2}$ "  
Hex Head Screw  
(Provided)



Longer #6 Hex Head Screw  
for Use with Spacer Blocks  
(Not Provided)



Speed Nut  
and Screw  
(Two Provided with  
Each Extension Bracket)

### Importance of Limit Stops on Window Shadings

Limit stops serve as the upper travel limit for the bottom rail, preventing it from rotating around the fabric roll. Limit stops are located 6" from the ends of the headrail or are centered on shadings less than 36" wide.

When a shading is made, the limit stops are adjusted according to the size of the fabric roll. Occasionally, this adjustment changes during shipping or installation. If this happens, problems can be fixed by readjusting the limit stops. See page 12 in the Troubleshooting section if shading operation is difficult or if the bottom rail rotates around the fabric roll. Shown below are the four possible positions of limit stops for large to small fabric rolls.

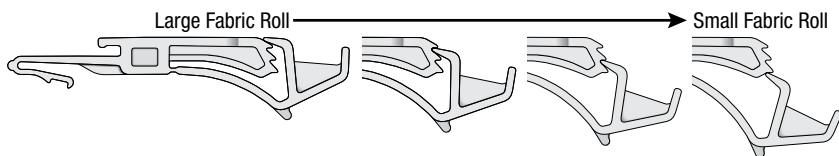

## Installation Overview

- Your order will include the correct number of installation brackets for your shading width, as shown in the table below.
- Shading orders may also include spacer blocks or extension brackets, if they were specified for added clearance.
  - Extension brackets are used for end mount shadings, as well.

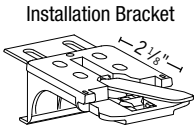

Installation Bracket

Panel Width	Brackets
18" – 36"	2
36 <sup>1</sup> / <sub>8</sub> " – 79"	3
79 <sup>1</sup> / <sub>8</sub> " – 84"	4

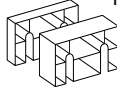

<sup>1</sup>/<sub>4</sub>" and <sup>1</sup>/<sub>2</sub>"  
Spacer Blocks

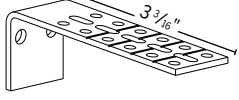

For Added Clearance  
Extension Bracket

## Mounting Types and Window Terminology

If the installation brackets are mounted correctly, the rest of the installation process follows easily. To prepare for this important first step, review the mounting types and basic window terminology illustrated below.

Molding

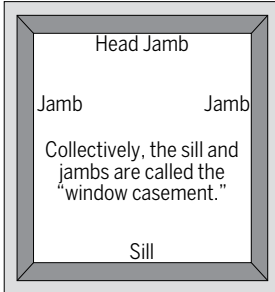

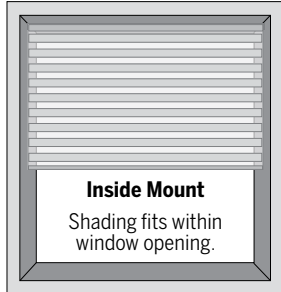

**Inside Mount**  
Shading fits within window opening.

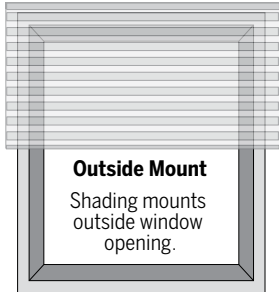

**Outside Mount**  
Shading mounts outside window opening.

**Shim**– A thin strip of material used to align parts to make them fit.

- Refer to the appropriate page below based on your order:
  - **Inside Mount**      **Page 6**
  - **Outside Mount**    **Page 7**
  - **Side Mount**        **Page 9**

# INSTALLATION



**CAUTION:** Failure to follow ALL installation instructions may cause the shading to fall, possibly resulting in injury or property damage.

## INSIDE MOUNT

### Prepare the Installation Brackets

- Use pliers or heavy-duty scissors to remove the TOP tab ONLY on the installation brackets.

**NOTE:** Save these tabs once removed. They may be used as shims, if necessary.

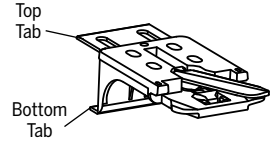

### Mount the Installation Brackets

- Mark 2" to 3" from each jamb for bracket location.
  - If more than two installation brackets came with your order, space additional bracket(s) evenly between the two end brackets and mark their location. Mount into wood whenever possible.

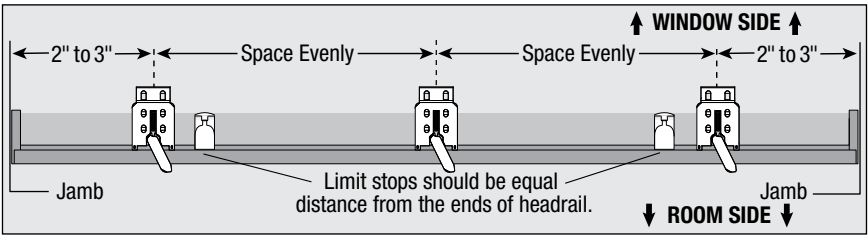

- Center the brackets on your marks, then mark the screw hole locations.

- The minimum casement depth for installation brackets is 1". Mark the rear set of installation bracket holes with shallow mounting depths.
- The minimum casement depth for a fully recessed mount is 3 3/4". Mark the front set of bracket holes when depth permits.

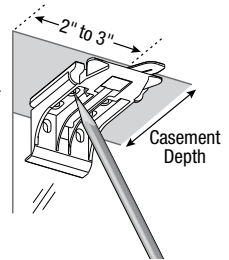

**IMPORTANT:** The front edges of the brackets must be level and aligned to each other.



**CAUTION:** Failure to properly align the brackets could result in the headrail releasing from the brackets, causing the shading to fall, possibly resulting in injury or property damage.

# INSTALLATION

- Drill the screw holes using a  $\frac{3}{32}$ " drill bit.

**IMPORTANT:** Use drywall anchors when mounting into drywall.

- Use a level to check that the mounting surface is level. Shim the brackets, if necessary. (Use the top tab that was removed from the brackets.)

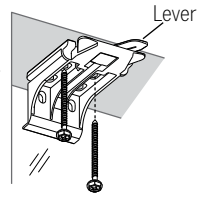

- Attach the installation brackets using the screws provided.

**IMPORTANT:** Do not overtighten the screws. Check to ensure the lever can be moved easily side to side. If not, loosen the screws in one-eighth turn increments until the lever can be moved easily.

**IMPORTANT:** The front edges of the installation brackets must be level and aligned to each other.

- If using spacer blocks:

- Stack spacer blocks on top of the installation brackets, as shown in image below,
- Using #6 Hex Head Screws long enough for secure installation (not provided), install screws up through the underside of the installation bracket and spacer blocks into mounting surface. Use the front set of bracket holes when depth permits.

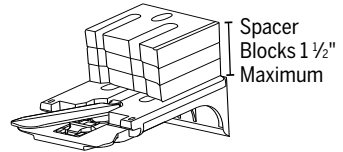

**IMPORTANT:** Do NOT add more than  $1\frac{1}{2}$ " of clearance using the spacer blocks.

**Proceed to "Install the Shading" on page 10.**

## OUTSIDE MOUNT

### Prepare the Installation Brackets

- Use pliers or heavy-duty scissors to remove both the top and bottom tabs on the installation brackets.

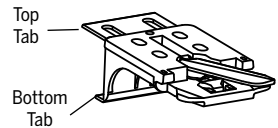

**NOTE:** Save these tabs once removed. They may be used as shims, if necessary.

### Mount the Installation Brackets

- Center the headrail over the window opening at the desired height. Use a pencil to lightly mark each end of the headrail.
  - Alternatively, measure the width of the headrail and use that width to mark the headrail end points over the window opening.
- Mark 2" to 3" from each end of the headrail.
  - If more than two installation brackets came with your order, space additional bracket(s) evenly between the two end brackets and mark their location. Mount into wood whenever possible.

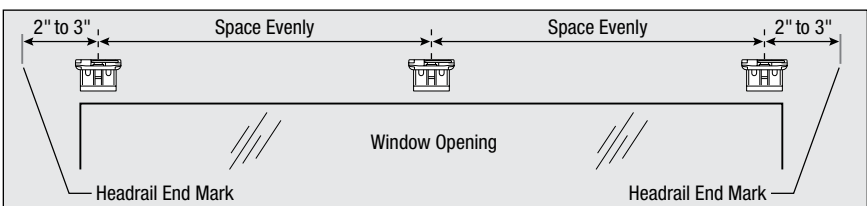

## INSTALLATION

---

- Center the installation brackets or extension brackets on your marks and mark where to drill the screw holes.
  - A minimum  $1\frac{1}{8}$ " flat vertical surface is required for the installation brackets. Extension brackets require  $1\frac{1}{4}$ ".
  - The tops of the installation brackets or extension brackets should be at the desired height. The brackets should be level and aligned.

**IMPORTANT:** The rear of the brackets must be flush against a flat mounting surface. Do NOT mount brackets on curved molding.

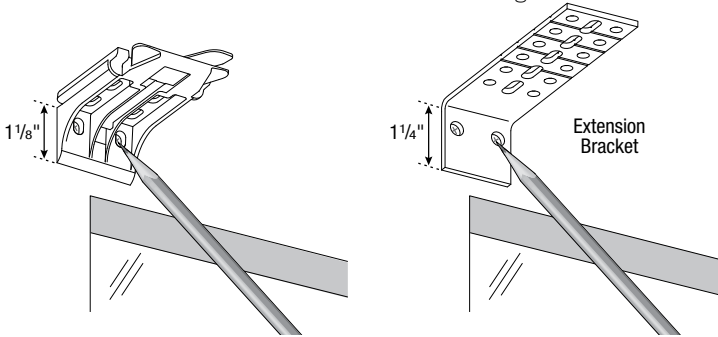

- Drill the screw holes using a  $\frac{3}{32}$ " drill bit.

**IMPORTANT:** Use drywall anchors when mounting into drywall.

- Attach the installation or extension brackets using the screws provided.

**IMPORTANT:** The tops of the installation brackets or extension brackets must be level with their front edges aligned.

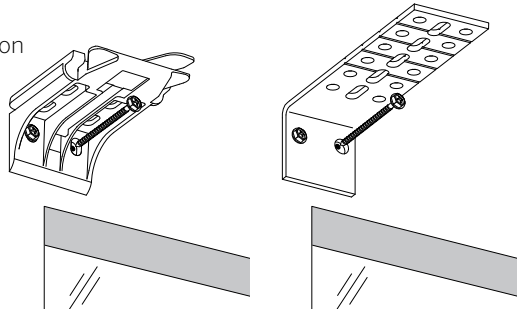



- If using spacer blocks:
  - Stack spacer blocks on the backside of the installation brackets
  - Using #6 Hex Head Screws long enough for secure installation (not provided), install screws through the installation bracket and spacer block into mounting surface.

**IMPORTANT:** Do NOT add more than 1 1/2" of clearance using spacer blocks.

**IMPORTANT:** The tops of the installation brackets must be level, with the front edges aligned.

**IMPORTANT:** Use drywall anchors when mounting into drywall.

- If using extension brackets, attach an installation bracket to the underside of each extension bracket using the speed nuts and screws provided.

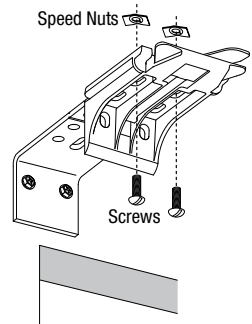
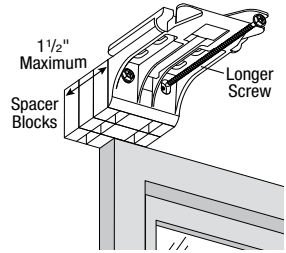

**Proceed to “Install the Shading” on page 10.**

## Side Mount

### Prepare the Installation Brackets

- Use pliers or heavy duty scissors to remove BOTH the top and bottom tabs on the installation brackets.

**NOTE:** Save these tabs once removed. They may be used as shims, if necessary.

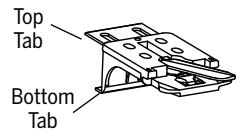

### Mount the Installation Brackets

Side mount the headrail when conventional mounting techniques will not work — for example, in an arched window opening.

- Mount the extension brackets on a surface at least 1 1/4" wide.
- Attach the installation brackets to the extension brackets using the provided screws and speed nuts.

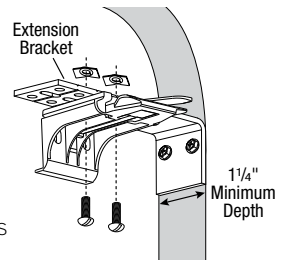

**CAUTION:** When securing side mounted shadings into a surface other than a secure wall stud, use medium to heavy-duty wall anchors (not provided). Match anchors to the wall thickness. Failure to mount the brackets securely may result in injury or property damage.

**NOTE:** Spacer blocks cannot be used with side mount installations.

**Proceed to “Install the Shading” on page 10.**

# INSTALLATION

## Install the Shading

- Position the shading so that the front faces you.
- Slide the headrail into the installation brackets so the edge of the headrail is between the lever and the bracket, as shown.
- Firmly push the headrail into each bracket until it clicks and the lever snaps to the right side of the bracket.

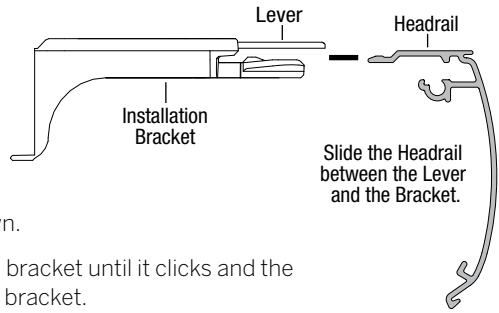

**IMPORTANT:** Carefully pull on the headrail at each bracket to ensure it is installed securely.

## Attach the Magnetic Hold-Down Brackets (Optional)

- Lower the shading keeping the vanes closed.
- Place the magnetic hold-down bracket onto the bottom rail just inside the end cap, oriented as shown.
- Hold the bracket while opening and closing the vanes (it may be necessary to have someone else assist you). Adjust the bracket to the best overall position.
- Mark the screw location using the mounting options shown below.
  - The screw should be placed in the middle of the channel. This will allow for adjustment.

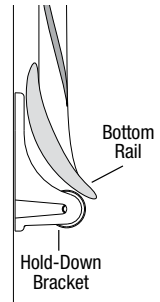

### Outside Mount



Preferred



Alternate

### Inside Mount



Preferred



Alternate

- Drill the screw holes using a  $\frac{3}{32}$ " drill bit.

**CAUTION:** Use drywall anchors when mounting into drywall.

- Attach the hold-down brackets to the mounting surface using the screws provided.
- If necessary, adjust bracket height by loosening the screw and sliding the bracket up or down.

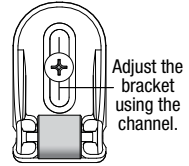

## Operate the Shading

### To Lower the Shading

- Gently pull down on the hinge pull tab.

### To Open the Vanes

- Lower the shading all the way down and continue pulling down on the handle until the vanes open.

### To Close the Vanes and Raise the Shading

- Pull down on the hinge pull tab slightly (1"-2") and release. The vanes will close first and then the shading will retract into the headrail.

**NOTE:** With inside mounted shadings, you may need to pull the hinge pull tab away from the window to release the locking mechanism and retract the shade.

**NOTE:** To hide the pull tab, rotate the tab backwards under the bottom rail once the shade is set in the desired position.

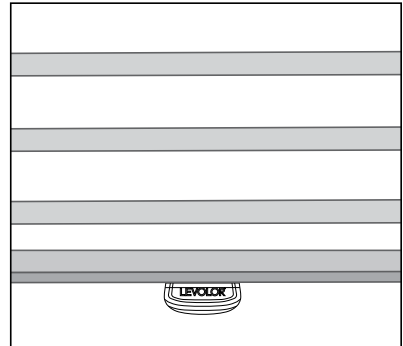
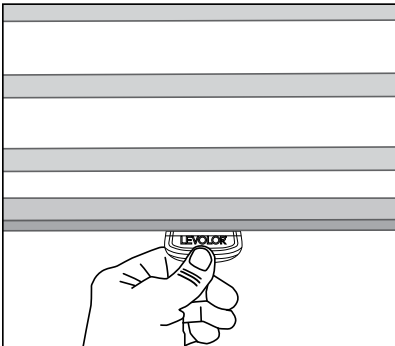

# OPERATION

## Troubleshooting

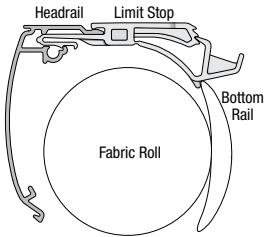
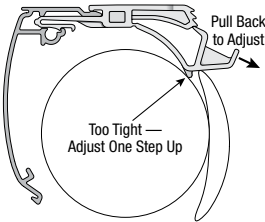
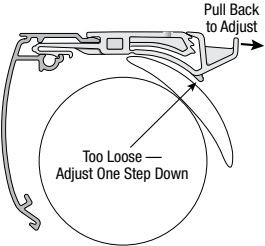
<b>Problem</b>	The shading will not snap into the installation brackets.
<b>Solution</b>	Check that the installation brackets are aligned and level. Check that the locking lever on the installation bracket slides over the headrail.
<b>Problem</b>	The shading is hard to raise or lower, or the bottom rail does not stop at the top limit.
<b>Solution</b>	<p>Check the adjustment position of ALL limit stops. The top illustration shows the correct adjustment. The limit stop catches the bottom rail, and the bottom of the limit stop is slightly above or barely touching the fabric roll.</p>  <p>In the second illustration, the limit stop adjustment is too tight. The fabric may not drop freely and could even be damaged when the shading is raised. To correct this, the limit stop should be adjusted one step up. Simply pull back on the rear of the limit stop to adjust its position.</p>  <p>In the bottom illustration, the adjustment is too loose. The bottom rail can slip under the limit stop. If the bottom rail rotates through the headrail, it must be backed out before adjusting the limit stop.</p>  <p><b>IMPORTANT:</b> ALL limit stops must be adjusted to the same position or else skewing may occur.</p>

**Troubleshooting**

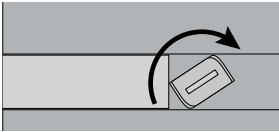
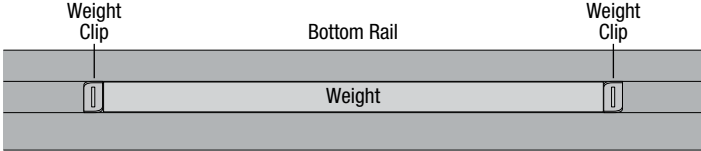
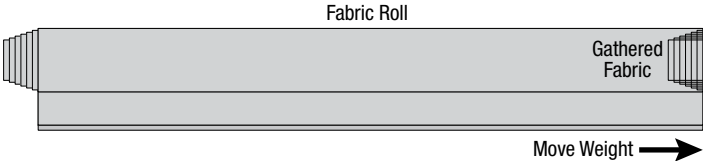
<p><b>Problem</b></p>	<p>The shading is hard to raise or lower, or will not raise or lower.</p>
<p><b>Solution</b></p>	<p>Shadings cannot be forced into tight inside mount window openings. If an inside mount, check that the shading is installed correctly. Make sure there is clearance between the ends of the shading and the window casement.</p> <p>Check that the installation brackets are level. Shim to level, if necessary.</p> <p>Check that the shading fabric is not catching on any brackets or window components.</p>
<p><b>Problem</b></p>	<p>The shading raises or lowers unevenly, the fabric rubs against one end of the headrail, or the bottom rail is uneven when fully raised.</p>
<p><b>Solution</b></p>	<p>Check that the window is square by measuring the diagonals.</p> <p>Check that the installation brackets are level. Shim to level, if necessary.</p> <p>Adjust the bottom rail weight. See below.</p> <p><b>Adjusting the Bottom Rail Weight</b></p> <ul style="list-style-type: none"> <li>Release the weight clips by inserting a flat head screwdriver into the weight clip and turning clockwise.</li> </ul>   <ul style="list-style-type: none"> <li>Move the weight in 1" increments toward the side where the fabric is gathering.</li> </ul>  <ul style="list-style-type: none"> <li>Secure the weight clips in position by turning them counterclockwise after making the adjustment.</li> <li>Test and, if necessary, adjust again.</li> </ul>

# OPERATION

---

## Troubleshooting

<b>Problem</b>	Vanes do not align on side-by-side shadings.
<b>Solution</b>	<p>Vane alignment can only be ensured within 1/4" when shadings are ordered at the same time, at the same height, with the same color, same operating system and fabric, and when specified on the order form.</p> <p>Check that the windows are square and the same height.</p>
<b>Problem</b>	The hinge pull tab is not centered on the shade.
<b>Solution</b>	<ul style="list-style-type: none"><li>• Release the weight clips by inserting a flat head screwdriver into the weight clip and turning clockwise</li><li>• Move the weights along the bottom rail so the hinge pull tab is free to move</li><li>• Slide the hinge pull tab to the desired location on the shade</li><li>• Secure the weight clips in position by turning them counterclockwise after making the adjustment. (See Adjusting Bottom Rail Weight on page 13.)</li></ul>

## Removing the Shading

- Move the lever on the installation brackets to the left to release the shading.

- A flat head screwdriver can be used to move the lever.

**IMPORTANT:** Be very careful to not tear or damage any of the fabric.

- If the lever is inaccessible or inoperable, lower the shading until you can see the underside of the bracket. Carefully reach a small flat head screwdriver behind the shading to the tab on bottom of the bracket between the screw holes.
- Push the tab away from the shading and pull the headrail to release it from the bracket.

- Carefully pull the shading to remove it from the brackets.

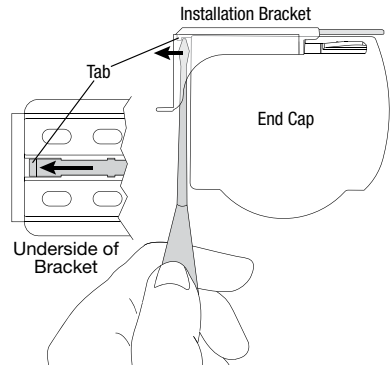
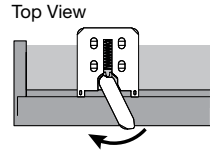

## Cleaning Procedures

Sheer Shadings are made of 100% polyester, which means they are inherently durable and resilient. However, care must be taken to avoid wrinkling the fabric, particularly where the vanes meet the facings.

### Dusting

- Regular light dusting with a feather duster is all the cleaning that is needed in most circumstances.

### Vacuuming

- Use a low suction, hand-held vacuum for more thorough dust removal.

### Forced Air

- Blow away dirt and debris between the vanes using clean compressed air.

### Spot-Cleaning

- Do NOT spot-clean Sheer Shadings.

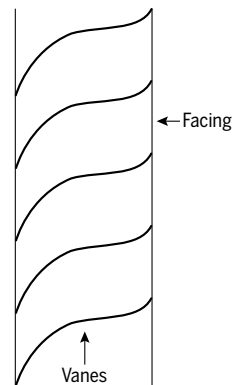

# CARE

---

## **Ultrasonic Cleaning**

Sheer Shadings can be ultrasonically cleaned by a professional with the exception of light-dimming fabrics.

- Specify that a mild detergent solution be used.
- Never immerse the headrail in the solution.
- Dry the shading completely in the lowered position.

## **Injection/Extraction**

Sheer Shadings can be professionally cleaned using the injection/extraction method.

- A dry method of injection/extraction is required for light-dimming fabrics.
- Never immerse the headrail in the solution.

## **Electrostatic Cleaning**

Do NOT use electrostatic cleaning wipes on any sheer shadings.

## **A Note About Fabrics**

As with all textiles, Sheer Shading fabrics are subject to some variations. Slight wrinkling, puckering, or bowing is inherent to this textile product and should be considered normal, acceptable quality. These characteristics are not usually visible from the front or rear but may be visible from a side angle.

Precautions should be taken to reduce exposure to harsh environmental elements, such as salt air. Continuous exposure through open windows and doors will accelerate the fabric deterioration.

**NOTE:** Improper cleaning may void warranty.

## **Warranty**

For complete warranty information visit [levolor.com](http://levolor.com) or call customer service at 1-800-LEVOLOR or 1-800-538-6567.



